

**TOGETHER<sup>®</sup>**

**Smart Cooling Solutions**

**Product catalogue 2024**

**05 April 2024**

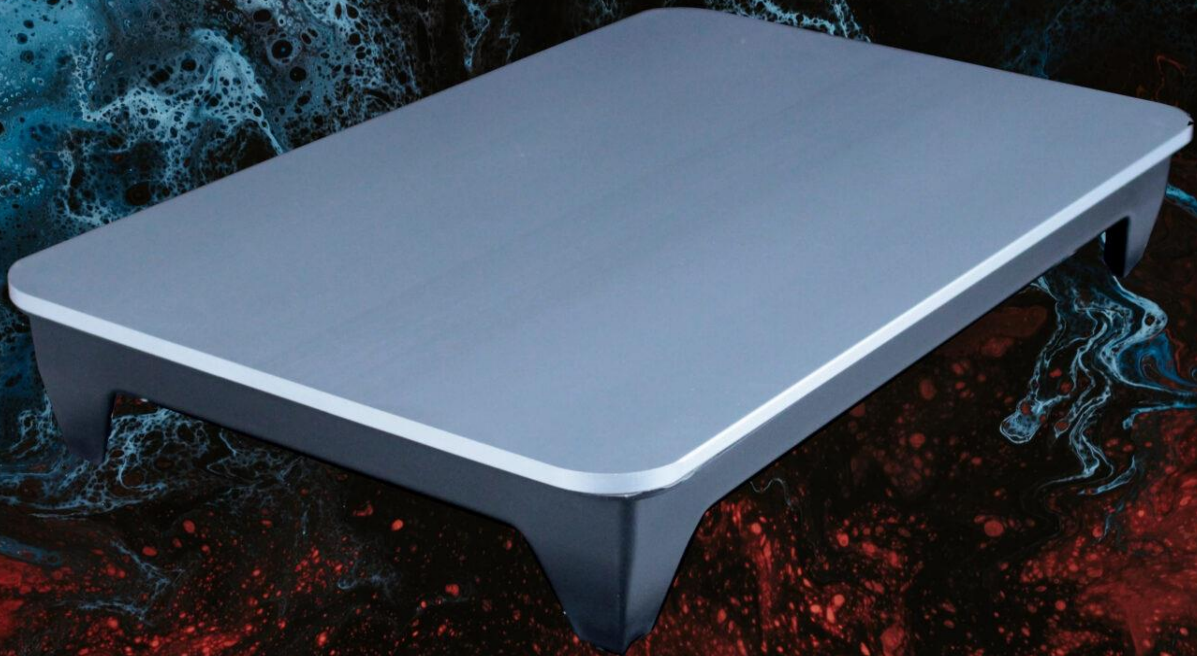

Hot- & Cold-Plates mobil

Hot- & Cold-Plates for built-in

Hot- & Cold-Plates for drop-in drop-out

Hot & Cold Buffet-Systems

Hot & Cold Buffet-Display-Cases



## Table of Contents

<b>Hot and Cold Plates – Discover the varieties!</b> .....	4
Hot- & Cold-Plate Model 3300 for counter-top/ table-top, flexible, mobile, or stationary use ...	5
Hot- & Cold-Plate Model 3400 for Built-in use in stationary furniture .....	7
Hot- & Cold Plate Model 3500, for Drop-in, plug-in and out, flexible, mobile, stationary use ...	8
<b>Refrigerated Buffet System - Discover the varieties!</b> .....	9
Refrigerated Buffet Systems acrylic design.....	10
Model Series Elegance.....	10
Model Series Octa.....	11
Refrigerated Buffet Systems coloured frame .....	12
Model Series Style .....	12
Refrigerated Buffet Systems natural wood.....	13
Model Series Country House .....	13
Model Series Country House Wood Art .....	14
<b>Refrigerated Buffet Display Cases - Discover the varieties!</b> .....	15
Refrigerated Buffet Display Case acrylic design.....	16
Model Series Elegance+ .....	16
Refrigerated Buffet Display Cases natural wood .....	17
Model Series Country House+ .....	17
Model Series Country House Wood Art+ .....	18
Refrigerated Buffet Display Case coloured frame .....	19
Model Series Style+ .....	19
<b>Technical Explanations</b> .....	21
Explanations Special Multi-Volt Power Supply .....	22
Explanations for flush installation or raised installation guilty only for Hot- and Cold-Plates model 3400 and 3500 for built-in in countertops and furniture. ....	23
Explanations air kit only for Hot- and Cold-Plate model 3400 for built-in in countertops and furniture .....	24
<b>Benefits for all models</b> .....	25
<b>About us</b> .....	26
Our mission .....	26
Our vision.....	26

Our claim .....26









Our ambition .....26

Our values .....26

The TOGETHER GmbH company history .....27

**GENERAL CONDITIONS.....28**

**Hot and Cold Plates – Discover the varieties!**

	<table border="0"> <tr> <td style="text-align: center;"> <p><b>24/7 cooling</b></p>  <p><b>+4°C/+6°C*</b> No freezing on the plate surface, stable temperature 24/7, no need to regulate the temperature.</p> </td> <td style="text-align: center;"> <p><b>24/7 warming</b></p>  <p><b>+65°C*</b> No burning on the plate surface, stable temperature 24/7, no need to regulate the temperature.</p> </td> </tr> </table>	<p><b>24/7 cooling</b></p>  <p><b>+4°C/+6°C*</b> No freezing on the plate surface, stable temperature 24/7, no need to regulate the temperature.</p>	<p><b>24/7 warming</b></p>  <p><b>+65°C*</b> No burning on the plate surface, stable temperature 24/7, no need to regulate the temperature.</p>	
<p><b>24/7 cooling</b></p>  <p><b>+4°C/+6°C*</b> No freezing on the plate surface, stable temperature 24/7, no need to regulate the temperature.</p>	<p><b>24/7 warming</b></p>  <p><b>+65°C*</b> No burning on the plate surface, stable temperature 24/7, no need to regulate the temperature.</p>			
<p><b>hot or cold – by simply flipping a switch</b></p>				

\* = at 20°C ambient temperature

*These innovative Hot & Cold Plates for the buffet combine two functions (hot/cold) in one device. Simply place the serving plate with food on it and select the desired temperature range (hot/cold) – that's it, cooling and warming 24/7 without any further work.*

*No more annoying handling of ice cubes, ice packs, crushed ice, eutectic plates, or precooling, this saves working time.*

*No conversion of the cooling/heating technology necessary. You can choose between the warm/off/cold functions just by flipping a switch, this saves working time and investment costs.*

*The guest is not disturbed by changing ice cubes or ice packs. This increases the feel-good atmosphere for the guest. Another advantage is that the temperature on the serving plate always remains the same. The food is always well chilled. All this increases the well-being of the guests.*

*We offer three models of Hot- and Cold Plates one for tabletop/ countertop use, one for built in in furniture and one for drop-in and out for mobile stationary or temporary use.*

*Since no refrigerant is used, the panels can be transported and stored without any problems. Driving over uneven floors, storing it at an angle or upright, or even upside down is no problem.*

Hot- & Cold-Plate Model 3300 for counter-top/ table-top, flexible, mobile, or stationary use



hot or cold –  
by simply flipping a switch

24/7  
cooling



+4°C/+6°C\*  
No freezing on the plate surface, stable temperature 24/7, no need to regulate the temperature.

24/7  
warming



+65°C\*  
No burning on the plate surface, stable temperature 24/7, no need to regulate the temperature.

These innovative Hot & Cold Plates table-top/ countertop is the ideal solution for presenting chilled or warmed food, finger food and snacks on a hotel and restaurant buffet, at events or exhibitions.

The Hot and Cold Plate 3300 can be used both, stationary and mobile. With a weight of only 8 kg and its small dimensions, it is easy to handle.

These Hot- and Cold Plates combines two functions (hot/cold) in one device, this saves investment costs.

Simply place the serving plate with food on it and select the desired temperature range (hot/cold) – that’s it. You can choose between the warm/off/cold functions just by flipping a switch. Cooling and warming 24/7 without any further work. No more annoying handling of ice cubes, ice packs, crushed ice, eutectic plates, or precooling, no conversion of the cooling/heating technology necessary, both aspects save worktime.



Discover the advantages and different colours of our Hot- & Cold-Plates Model 3300 counter-top/ table-top use, on our website.





EAN: 4032158040016

**TOGETHER 3300**

Electric Hot- and Cold-Plate  
with substructure in black  
inclusive special Multi-Volt Power Supply



EAN: 4032158040023

**TOGETHER 3300-grey**

Electric Hot- and Cold-Plate  
with substructure in grey  
inclusive special Multi-Volt Power Supply



EAN: 4032158040030

**TOGETHER 3300-silver**

Electric Hot- and Cold-Plate  
with substructure in silver  
inclusive special Multi-Volt Power Supply



EAN: 4032158040047

**TOGETHER 3300-carbon**

Electric Hot- and Cold-Plate  
with substructure in carbon  
inclusive special Multi-Volt Power Supply

## Hot- & Cold-Plate Model 3400 for Built-in use in stationary furniture



**hot or cold –**  
by simply flipping a switch

**24/7  
cooling**



**+4°C/+6°C\***  
No freezing on the plate surface, stable temperature 24/7, no need to regulate the temperature.

**24/7  
warming**



**+65°C\***  
No burning on the plate surface, stable temperature 24/7, no need to regulate the temperature.

The TOGETHER Hot and Cold Plates generate the cold purely electrically. No bulky compressors or refrigerants that may be harmful to the environment are used. The innovative technology made it possible to limit the overall height of the entire hot and cold plate to 80 mm. The space below the hot and cold plate can be used for shelves, drawers or other things or can be left open. Installation and maintenance are very easy. Installation without the need for cooling compressors, cooling pipes or other complicated procedures. No refrigeration/air conditioning technician is required for installation. This saves money during installation and eliminates the need for regular cost intensive maintenance by specially trained personnel within the service life.

These innovative Hot & Cold Plates for the buffet combine two functions (hot/cold) in one device. Simply place the serving plate with food on it and select the desired temperature range on the switch (hot/cold) – that's it.

 <p><b>TOGETHER</b></p> <p>EAN: 4032158040207</p> 	<p><b>TOGETHER 3400 for built-in</b></p> <p>Electric Hot- and Cold-Plate with exposed control element inclusive special Multi-Volt Power Supply and air kit consists of 1 x corrugated hose, 2 x hose adapter, 2 x hose clamp</p>
--	---

Cooling and warming 24/7 without any further work. No longer ice tubs or cooling elements, no more annoying handling of ice cubes, crushed ice, no precooling of eutectic plates or ice packs.

\* = at 20°C ambient temperature

Hot- & Cold Plate Model 3500, for Drop-in, plug-in and out, flexible, mobile, stationary use



hot or cold –  
by simply flipping a switch

24/7  
cooling



+4°C/+6°C\*  
No freezing on the plate surface, stable temperature 24/7, no need to regulate the temperature.

24/7  
warming



+65°C\*  
No burning on the plate surface, stable temperature 24/7, no need to regulate the temperature.

*These plug-in Hot & Cold-Plates are from interest for using in serving trolleys, mobile/ flexible units, catering stations during event catering, trade fairs, store fitting etc. and if designer want to create elegant and high-end cooled service points for food presentation. Since no refrigerant is used, the panels can be transported and stored without any problems. Driving over uneven floors, storing it at an angle or upright, or even upside down is no problem. The lack of conventional refrigeration technology makes the devices insensitive to vibrations and shocks. The low weight of 8 kg makes transport and storage easier.*

*No conversion of the cooling/heating technology necessary. You can choose between the warm/off/cold function just by flipping a switch. No longer ice tubs or cooling elements, no more annoying handling of ice cubes, crushed ice, no precooling of eutectic plates or ice packs.*

\* = at 20°C ambient temperature

 	<p><b>TOGETHER 3500 for plug-in and out</b></p> <p>Electric Hot- and Cold-Plate inclusive special Multi-Volt Power Supply</p> <p>EAN: 4032158040221</p>
---	---



**Refrigerated Buffet System - Discover the varieties!**

Save your employees' working time and increase the satisfaction of your guests



**hot or cold –**  
by simply flipping a switch

**24/7  
cooling**



**+4°C/+6°C\***  
No freezing on the plate surface, stable temperature 24/7, no need to regulate the temperature.

**24/7  
warming**



**+65°C\***  
No burning on the plate surface, stable temperature 24/7, no need to regulate the temperature.

---

*These innovative Hot & Cold Buffet Systems for the buffet combine two functions (hot/cold) in one device. Simply place the serving plate with food on it and select the desired temperature range (hot/cold) – that's it, cooling and warming 24/7 without any further work.*

*No more annoying handling of ice cubes, ice packs, crushed ice, eutectic plates, or precooling.*

*No conversion of the cooling/heating technology necessary. You can choose between the warm/off/cold functions just by flipping a switch.*

*The guest is not disturbed by changing ice cubes or ice packs. This increases the feel-good atmosphere for the guest. Another advantage is that the temperature on the serving plate always remains the same. The food is always well chilled. This increases the well-being of the guests.*

---

\* = at 20°C ambient temperature

## Refrigerated Buffet Systems acrylic design

### Model Series Elegance

**The Buffet Systems Model Elegance consists of:**

Hot- & Cold-Plate Model 3300 in combination with a very solid design acrylic glass frame with clear lines and 1/1 GN stainless steel serving plate, inclusive special Multi-Volt Power Supply



check it out on our website

**Electric Cooled Buffet System Elegance**

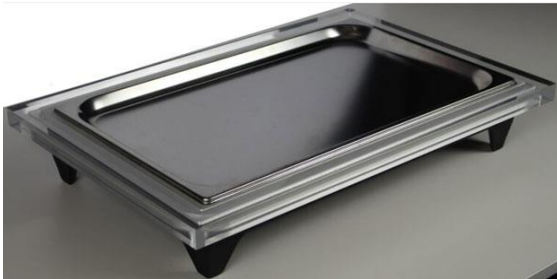

EAN: 4032158040306

Substructure in black colour

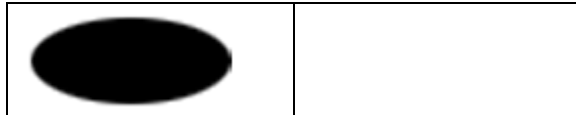

**Electric Cooled Buffet System Elegance-grey**



EAN: 4032158040320

Substructure in grey colour

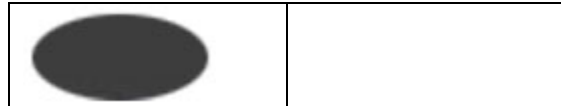

**Electric Cooled Buffet System Elegance-silver**



EAN: 4032158040347

Substructure in silver colour

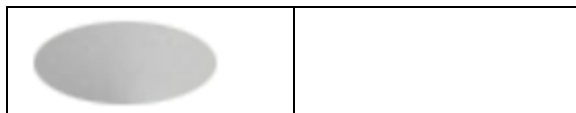

**Electric Cooled Buffet System Elegance-carbon**



EAN: 4032158040368



Substructure in carbon colour



Refrigerated Buffet Systems acrylic design

Model Series Octa

<p><b>The Buffet Systems Model Octa consists of:</b>          Hot- &amp; Cold-Plate model 3300 in combination with acrylic glass layer with rounded edges and eight square stainless steel serving tray, inclusive special Multi-Volt Power Supply.</p>	 <p>check it out on our website</p>
---	--

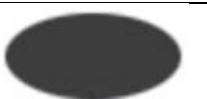
<p><b>Electric Cooled Buffet System Octa</b></p>  <p>EAN: 4032158040443          Substructure in black colour</p> 	<p><b>Electric Cooled Buffet System Octa-grey</b></p>  <p>EAN: 4032158040450          Substructure in grey colour</p> 
---	---

<p><b>Electric Cooled Buffet System Octa-silver</b></p>  <p>EAN: 4032158040467          Substructure in silver colour</p> 	<p><b>Electric Cooled Buffet System Octa-carbon</b></p>  <p>EAN: 4032158040474          Substructure in carbon colour</p> 
--	--



Refrigerated Buffet Systems coloured frame

Model Series Style

<p><b>The Buffet Systems Model Style consists of:</b> Hot &amp; Cold-Plate with a handcrafted solid wooden frame in the standard colour light grey and 1/1 GN stainless steel serving plate, inclusive special Multi-Volt Power Supply.</p>		<p>check it out on our website</p>
---	---	------------------------------------

<p><b>Electric Cooled Buffet System Style</b> EAN: 4032158040559</p>  <p style="text-align: right;"><b>TOGETHER®</b></p> <p>Substructure in black colour</p>	<p><b>Electric Cooled Buffet System Style-grey</b> EAN: 4032158040573</p>  <p style="text-align: right;"><b>TOGETHER®</b></p> <p>Substructure in grey colour</p>
	





<p><b>Electric Cooled Buffet System Style-silver</b> EAN: 4032158040597</p>  <p style="text-align: right;"><b>TOGETHER®</b></p> <p>Substructure in silver colour</p>	<p><b>Electric Cooled Buffet System Style-carbon</b> EAN: 4032158040610</p>  <p style="text-align: right;"><b>TOGETHER®</b></p> <p>Substructure in carbon colour</p>
	





<p><b>Electric Cooled Buffet System custom-made</b></p>  <p style="text-align: right;"><b>TOGETHER®</b></p>	<p>Substructure you can chose between the standard colours black, grey, silver, carbon, other colours on request. With a handcrafted solid wooded frame, colour can be chosen, 213 different RAL colours or private designs are possible</p>
--	--

Refrigerated Buffet Systems natural wood

Model Series Country House

<p><b>The Buffet Systems Model Country House consists of:</b> Hot &amp; Cold-Plate with a handcrafted solid wood frame with surrounding trim and 1/1 GN stainless steel serving plate, inclusive special Multi-Volt Power Supply.</p>		<p>check it out on our website</p>
---	---	------------------------------------





<p><b>Electric Cooled Buffet System Country House</b></p>	<p><b>Electric Cooled Buffet System Country House-grey</b></p>
	
<p>EAN: 4032158040801 Substructure in black colour</p>	<p>EAN: 4032158040825 Substructure in grey colour</p>
	





<p><b>Electric Cooled Buffet System Country House-silver</b></p>	<p><b>Electric Cooled Buffet System Country House-carbon</b></p>
	
<p>EAN: 4032158040849 Substructure in silver colour</p>	<p>EAN: 4032158040863 Substructure in grey colour</p>
	

Refrigerated Buffet Systems natural wood

Model Series Country House Wood Art

<p><b>The Buffet Systems Model Country House Wood Art consists of:</b>          Hot &amp; Cold-Plate Hot &amp; Cold-Plate with handcrafted solid wood frame with a surrounding trim. On the front, the decorative strip is interrupted by a typical country house motif hand-carved by an artist. 1/1 GN stainless steel serving plate, inclusive special Multi-Volt Power Supply</p>		<p>check it out on our website</p>
---	---	------------------------------------

<p><b>Electric Cooled Buffet System Country House Wood Art</b></p>	<p><b>Electric Cooled Buffet System Country House Wood Art-grey</b></p>
	
<p>EAN: 4032158040900 Substructure in black colour</p>	<p>EAN: 4032158040924 Substructure in grey colour</p>
	

<p><b>Electric Cooled Buffet System Country House Wood Art-silver</b></p>	<p><b>Electric Cooled Buffet System Country House Wood Art-carbon</b></p>
	
<p>EAN: 4032158040948 Substructure in silver colour</p>	<p>EAN: 4032158040962 Substructure in carbon colour</p>
	



**Refrigerated Buffet Display Cases - Discover the varieties!**

Mobile or stationary, TOGETHER® Hot & Cold Electric Cooling Display Cases for breakfast, lunch, and dinner buffets and for all businesses and applications wherever there is insufficient space for a conventional refrigerated display cabinet.



**hot or cold –**  
by simply flipping a switch

**24/7  
cooling**



**+4°C/+6°C\***

No freezing on the plate surface, stable temperature 24/7, no need to regulate the temperature.

**24/7  
warming**



**+65°C\***

No burning on the plate surface, stable temperature 24/7, no need to regulate the temperature.

*These innovative Hot & Cold Buffet Display Cases combine two functions (hot/cold) in one device. Simply place the serving plate with food on it and select the desired temperature range (hot/cold) – that's it, cooling and warming 24/7 without any further work.*

*No more annoying handling of ice cubes, ice packs, crushed ice, eutectic plates, or precooling.*

*No conversion of the cooling/heating technology necessary.*

*The guest is not disturbed by changing ice cubes or ice packs.*

*This increases the feel-good atmosphere for the guest.*









*Another advantage is that the temperature on the serving plate always remains the same. The food is always well chilled. This increases the well-being of the guests.*









\* = at 20°C ambient temperature

Refrigerated Buffet Display Case acrylic design

Model Series Elegance+

<p><b>The Buffet Systems Model Elegance+ consists of:</b>          Hot- &amp; Cold-Plate Model 3300 with a particularly solid acrylic glass design frame and an acrylic glass rolltop cover with handle in silver colour and a high-quality GN 1/1 stainless steel serving plate, inclusive special Multi-Volt Power Supply.</p>	 <p>check it out on our website</p>
--	--

<p><b>Electric Cooled Buffet Display Case model Elegance+</b></p>  <p>EAN: 4032158040313          Substructure in black colour</p> <table border="1" data-bbox="204 1229 782 1344"> <tr> <td></td> <td></td> </tr> </table>			<p><b>Electric Cooled Buffet Display Case model Elegance+ grey</b></p>  <p>EAN: 4032158040337          Substructure in grey colour</p> <table border="1" data-bbox="805 1229 1383 1344"> <tr> <td></td> <td></td> </tr> </table>		
					
					

<p><b>Electric Cooled Buffet Display Case model Elegance+ silver</b></p>  <p>EAN: 4032158040351          Substructure in black colour</p> <table border="1" data-bbox="204 1861 782 1971"> <tr> <td></td> <td></td> </tr> </table>			<p><b>Electric Cooled Buffet Display Case model Elegance+ carbon</b></p>  <p>EAN: 4032158040375          Substructure in black colour</p> <table border="1" data-bbox="805 1861 1383 1971"> <tr> <td></td> <td></td> </tr> </table>		
					
					

Refrigerated Buffet Display Cases natural wood

Model Series Country House+

**The Buffet Systems Model Country House+ consists of:**  
 Hot- & Cold-Plate Model 3300 with a handcrafted solid wood frame with surrounding trim, and an acrylic glass rolltop cover with handle in silver colour and a high-quality GN 1/1 stainless steel serving plate, inclusive special Multi-Volt Power Supply.



check it out on our website

**Electric Cooled Buffet System Country House+**



TOGETHER<sup>®</sup>

EAN: 4032158040818  
 Substructure in black colour



**Electric Cooled Buffet System Country House+ grey**



TOGETHER<sup>®</sup>

EAN: 4032158040832  
 Substructure in grey colour



**Electric Cooled Buffet System Country House+ silver**



TOGETHER<sup>®</sup>

EAN: 4032158040856  
 Substructure in silver colour



**Electric Cooled Buffet System Country House+ carbon**



TOGETHER<sup>®</sup>

EAN: 4032158040870  
 Substructure in carbon colour













Refrigerated Buffet Display Cases natural wood

Model Series Country House Wood Art+

<p><b>The Buffet Systems Model Country House Wood Art+ consists of:</b>                  Hot- &amp; Cold-Plate Model 3300 with handcrafted solid wood frame with a surrounding trim. On the front, the decorative strip is interrupted by a typical country house motif hand-carved by an artist and an acrylic glass rolltop cover with handle in silver colour and a high-quality 1/1 GN stainless steel serving plate, inclusive special Multi-Volt Power Supply</p>	 <p>check it out on our website</p>
---	--





<p><b>Electric Cooled Buffet System Country House Wood Art+</b></p>  <p>EAN: 4032158040917 Substructure in black colour</p> 	<p><b>Electric Cooled Buffet System Country House Wood Art+ grey</b></p>  <p>EAN: 4032158040931 Substructure in grey colour</p> 
---	---





<p><b>Electric Cooled Buffet System Country House Wood Art+ silver</b></p>  <p>EAN: 4032158040955 Substructure in black colour</p> 	<p><b>Electric Cooled Buffet System Country House Wood Art+ carbon</b></p>  <p>EAN: 4032158040979 Substructure in carbon colour</p> 
---	--

Refrigerated Buffet Display Case coloured frame

Model Series Style+

<p><b>The Buffet Systems Model Style+ consists of:</b>          Hot- &amp; Cold-Plate Model 3300 with a coloured handcrafted wooden frame, and an acrylic glass rolltop cover with handle in silver colour and a high-quality GN 1/1 stainless steel serving plate, inclusive special Multi-Volt Power Supply.</p>	 <p>check it out on our website</p>
--	--

<p><b>Electric Cooled Buffet Display Case model Style+</b></p>  <p>EAN: 4032158040566          Substructure in black colour</p> 	<p><b>Electric Cooled Buffet Display Case model Style+ grey</b></p>  <p>EAN: 4032158040580          Substructure in grey colour</p> 
---	---

<p><b>Electric Cooled Buffet Display Case model Style+ silver</b></p>  <p>EAN: 4032158040603          Substructure in silver colour</p> 	<p><b>Electric Cooled Buffet Display Case model Style+ carbon</b></p>  <p>EAN: 4032158040627          Substructure in carbon colour</p> 
--	--

**Electric Cooled Buffet Display Case model Style+ custom-made**

For the substructure you can chose between the standard colours black, grey, silver, carbon,



other colours on request. The picture shows the Electric Cooled Display Case with a substructure in pink colour.

The Colour of the handcrafted solid wood frame can be chosen between 213 different RAL colours. Also, private designs with brands or art designs are possible.



The Electric Cooled Buffet Display Case model Style+ custom-made comes standard with an acrylic glass rolltop cover with handle in silver colour. The handle can be changed against handles in other colours for example gold or other forms.

Further you will get a high-quality GN 1/1 stainless steel serving plate and a special Multi-Volt Power Supply.



## **Technical Explanations**

## Explanations Special Multi-Volt Power Supply

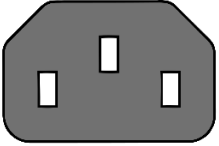
	<p>All our Hot- and Cold Plates comes with a Special Multi-Volt Power Supply. The prices showing in this price list are alle inclusive this power supply. For each cooling unit you need one power supply.</p> <p>The power supply can be used between 100-240 Vac / 50/60 Hz. With this power supply you can run our units nearly worldwide.</p> <p>One side of the power supply has a cable with an adapter on his end to connect our cooling units. This connection/ disconnection can be done without any tool only by click together.</p> <p>On the other side of the power supply is an adapter for plug in the power cord. This adapter is for using a power cord with IEC 13 connector.</p>
 <p>Power cord one side scuko plug other side IEC 13 connector (sample picture)</p>  <p>Schuko plug (CEE 7/3) for socket (CEE 7/4) (sample picture)</p>  <p>IEC 13 connector for connecting the power cord to the power supply (sample picture)</p>	<p>The power supply comes standard with a power cord having one side schuko plug (CEE 7/3) and other side an IEC 13 connector for connecting to the power supply. If you can ´t use a schuko plug in your country, you can buy a power cord with IEC 13 connector which is widely used throughout the world and the plug which is usable in your country.</p>

Explanations for flush installation or raised installation guilty only for Hot- and Cold-Plates model 3400 and 3500 for built-in in countertops and furniture.

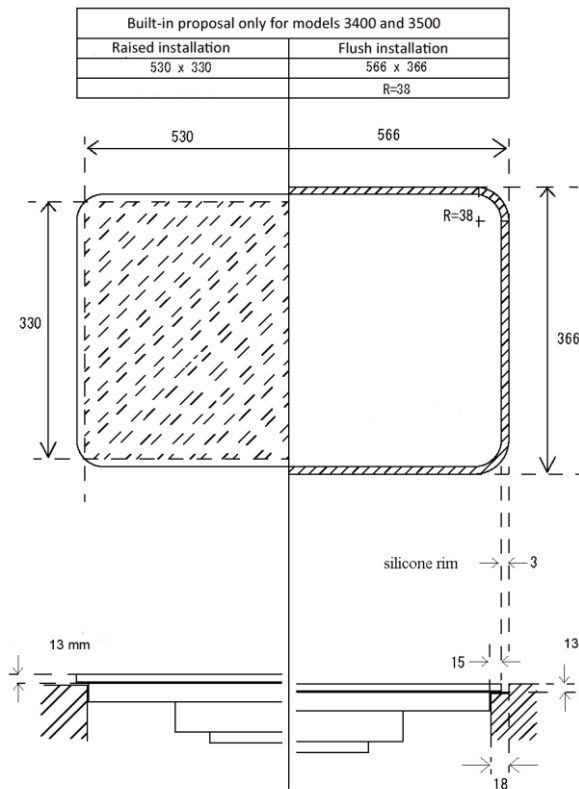

## Explanations air kit only for Hot- and Cold-Plate model 3400 for built-in in countertops and furniture

The Hot and Cold Plates model 3400 comes all time with an air kit. This air kit consists of 1 x corrugated hose, 2 x duct flange, 2 x hose clamp and is included in the price.



One of the adapters you fix with a screwdriver on the backside of the Hot and Cold Plate model 3400 where the ventilator is placed. Then you push the corrugated hose on the adapter and fix it with one of the hose clamps. After placing a round cut off on for example on the back side of the meuble, you fix the second adapter and afterwards you fix the corrugated hose in the same way as before. That's all, now fresh air is sucked from outside the meuble.

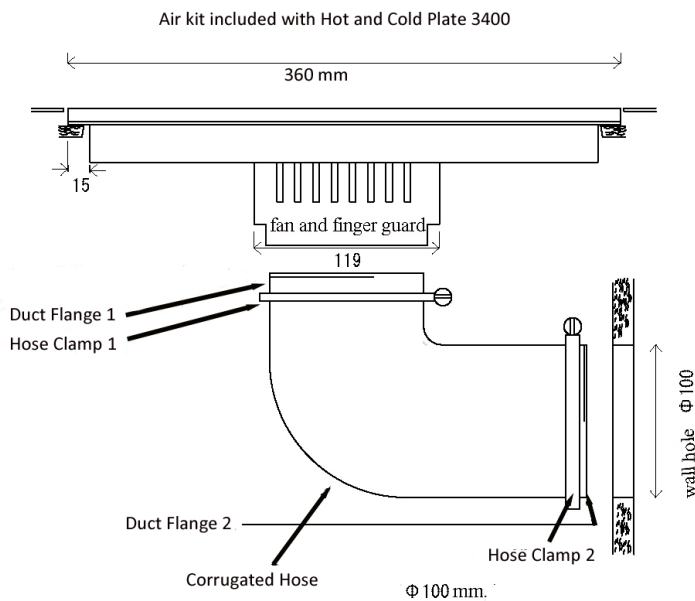



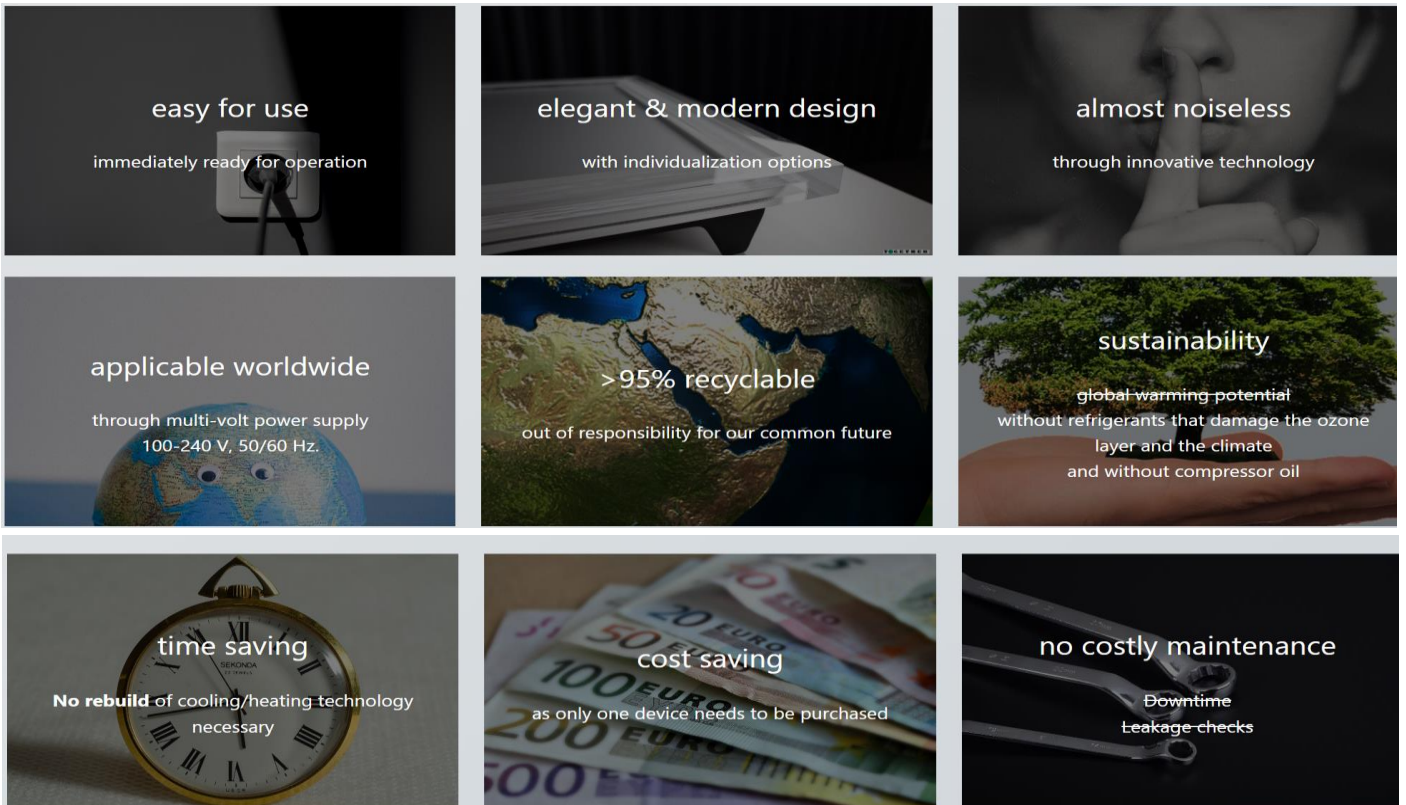

## Benefits for all models

*attractive design*

*compact size*

*low weigh*

*changing between the warm/off/cold function just by flipping a switch*

*immediately ready for operation*

*easy handling: simply place the serving plate with food, select the desired temperature range (hot/cold) - that's all to do, cooling and warming 24/7 without any further work.*

*food is always well chilled; this increases the well-being of the guests*

*no need of ice cubes, ice packs, crushed ice, eutectic plates, cold packs, ice packs, dry ice, or precooling*

*guests are not disturbed by changing ice cubes, ice packs..... or changing cooling/heating technology*

*suitable for use with serving plates/banquet plates up to a size of GN 1/1*

*almost noiseless*

*innovative technology*

*only one appliance needs to be purchased to realize a cooling and warming function*

*without ozone-depleting and climate-impacting refrigerants*

*without cooling compressor, no compressor oil*

*no refrigeration/air conditioning technician is required for installation*

*>95 % recyclable*

*no leakage check of cooling circuit*

*low power consumption*

*worldwide use 100-240 V, 50/60 Hz.*

## About us

TOGETHER® GmbH is an internationally active German manufacturer of innovative refrigeration solutions in the field of food presentation.

### Our mission

As a German manufacturer of unique refrigeration appliances, we want to shape the way chilled food is presented through innovation and the use of new technologies. TOGETHER® refrigeration solutions such as hot and cold plates, presentation and buffet systems are innovative and sustainable.

---

### Our vision

“Together we make a world of difference.”

We are convinced that “together we can make a big difference”. With innovative, resource-saving and durable solutions, we are able to protect the environment and at the same time increase efficiency in food presentation. At TOGETHER, we believe that the technology we use to present food chilled is a significant step towards protecting our environment.

---

### Our claim

The TOGETHER® brand stands for innovation and uniqueness. Our aim is to combine innovation in food presentation with high-quality design and German quality standards. We stand for inspiring our customers with outstanding products and individual services. Our team of experienced engineers, designers and industry experts strives to provide our customers with the latest technology to help them optimize their operations and improve customer satisfaction.

---

### Our ambition

The growing demand for efficient, environmentally friendly, individualized, and cost-effective solutions drives us to continuously push the boundaries of what is possible with a smart combination of technology and design. A particular incentive here is the input from our customers, who now come to us not only from the catering and hotel industry, but also from the shopfitting and exhibition stand construction sectors, and who are constantly developing new areas of application for our hot and cold plates.

---

### Our values

To live up to our claim, we live the corporate culture anchored in our company name “TOGETHER” (“together”).

We believe that we can only achieve our goals “together”. We therefore regard all stakeholders involved in our business, such as customers, suppliers, employees and indirectly involved persons, as our partners. In order to TOGETHER GmbH, Albert-Einstein-Str. 1, 95028 Hof/ Germany, [www.together-gmbh.com](http://www.together-gmbh.com)  
Prices and technical specifications are subject to change without prior notice.

work together effectively and to achieve a positive result for everyone involved, a “common” basis of trust is required. We live this not only internally, but also in cooperation with our customers. Our “shared” passion for innovation drives us forward and enables us to create unique products on the market.

---

#### The TOGETHER GmbH company history

TOGETHER GmbH was founded in 1994 and sold refrigerators and refrigerated displays under their own brand TOGETHER® nationally and internationally in the B2B sector. The benefits of and need for environmentally friendly refrigeration solutions were recognized early on.

In 1998, the “innovative cooling solutions” division was established within TOGETHER GmbH and the first Hot and Cold Plate for the buffet was developed to market maturity and launched under the TOGETHER® brand.

In 2003, the product portfolio was expanded to include a built-in version of the Hot and Cold Plate for fixed installation in countertop furniture.

In 2018 we presented a “built-in”/ “drop in and out” version of the Hot and Cold Plate for use in mobile or temporary units on the market.

Today TOGETHER® innovative cooling solutions have so far been sold in a total of 84 countries on all 5 continents.

---

## GENERAL CONDITIONS

**Prices:** Prices are quoted in EURO.

**Packaging:** Standard transport packaging included. Special packaging material like pallets, special carton, boxes, export crates, etc. must be paid.

**Delivery time:** To negotiate, smaller quantities 10 working days, larger quantities 20 - 30 working day, after payment of our order Confirmation and confirmed by our bank.

**Delivery terms:** Ex works/ Germany

**Payment terms:** Smaller quantities - Payment in advance including any bank fees, larger Quantities 30% advanced payment to start the production – 70% before delivery including any bank fees, custom made products 100% advanced payment including any bank fees, to start the production.

**Warranty:** 12 months trade in warranty, after the machine's shipment. Shipping charges are under the buyer's responsibility. The warranty does not cover damages occurred during the shipment or accidental breaks due to a wrong use of the machine by the final consumer.

**Shipment:** Shipment is effected at customer's expenses and risk.

**Safety certificate:** Our products have CE-mark, if not otherwise marked.

**Minimum order:** 1. EU – Countries 500,00 EURO / The customer agrees to sign an Entry Certificate 2. Countries outside EU 1.000,00 EURO

**Customs documents:** If the customer needs special export documents he must asked for these documents before placing any order. The costs for export documents will be invoiced separately.

**Operation manuals:** The operation manuals for our products are in German and English language. It is under the responsibility of the buyers to translate an operation manual in the language of their country or their needs.

**WEEE:** The act governing the sale, return and environmentally sound disposal of electrical and electronic equipment is under the responsibility of the buyers outside Germany.

**Packaging waste/ packaging regulation:** The take-back duty and the recycling of the packaging waste is under the responsibility of the buyers outside Germany.

**Prices, general conditions, and technical specifications are subject to change without prior notice.**



**T**  **G E T H E R**®

**TOGETHER GmbH**  
**Albert-Einstein-Straße 1**  
**95028 Hof/ Germany**

Tel.: +49 (0)9267 9142990

 [info@together-gmbh.com](mailto:info@together-gmbh.com)

[www.together-gmbh.com](http://www.together-gmbh.com)